



**BOSCH**



**Register** your  
new device on  
MyBosch now and  
get free benefits:  
**[bosch-home.com/  
welcome](https://bosch-home.com/welcome)**

# Tumble dryer

**WTW87561SG**

**en** Installation and operating instructions

## Your new tumble dryer

You have opted for a tumble dryer manufactured by Bosch.

Please take a few minutes to read and become familiar with the advantages of your tumble dryer.

To meet the high quality demands required by Bosch, every tumble dryer that leaves our factory is carefully checked to ensure that it functions correctly and is in perfect condition.

For more information on our products, accessories, replacement parts and services, see our website [www.bosch-home.com](http://www.bosch-home.com) or contact our Customer Service centres.

If the operating and installation instructions describe different models, any differences will be pointed out at the relevant points in the text.



Read these operating and installation instructions before operating the tumble dryer.

## Display rules

### **Warning!**

This combination of symbol and signal word indicates a possibly dangerous situation. Not heeding the warning can cause death or injuries.

### **Caution!**

This signal word indicates a possibly dangerous situation. Not heeding the caution can cause property and/or environmental damage.

### **Note/tip**

Information about the optimum use of the appliance/any other useful information.















### **1. 2. 3. / a) b) c)**

The steps are represented by numbers or letters.

■ / -

Lists are represented by a small box or a dash.

# Table of contents

 <b>Intended use</b> . . . . .	4	 <b>Operating the appliance</b> . . . . .	28
 <b>Safety instructions</b> . . . . .	4	Loading laundry and switching on the appliance . . . . .	28
Children/people/pets . . . . .	4	Setting a programme . . . . .	29
Installation . . . . .	6	Starting the programme . . . . .	29
Operation . . . . .	8	Programme progress . . . . .	29
Cleaning/Maintenance . . . . .	10	Changing the programme or adding more laundry . . . . .	30
 <b>Energy-saving tips</b> . . . . .	12	Cancelling the programme . . . . .	30
 <b>Installing and connecting the appliance</b> . . . . .	12	End of programme . . . . .	30
Scope of supply . . . . .	12	Removing laundry and switching off the appliance . . . . .	30
Installing the appliance . . . . .	13	Emptying the condensation container . . . . .	31
Connecting the appliance . . . . .	15	Removing the fluff . . . . .	32
Before using the appliance for the first time . . . . .	16	 <b>Draining the condensation water</b> . . . . .	33
Optional accessories . . . . .	16	 <b>Cleaning and maintenance</b> . . . . .	36
 <b>Appliance settings</b> . . . . .	17	Cleaning the appliance . . . . .	36
Childproof lock . . . . .	17	Cleaning the moisture sensor . . . . .	37
Activating setting mode . . . . .	17	Cleaning the filter in the condensation container . . . . .	38
Exiting setting mode . . . . .	18	 <b>Information on the display</b> . . . . .	39
 <b>Quick reference guide</b> . . . . .	19	 <b>Help with the appliance</b> . . . . .	40
 <b>Familiarising yourself with your appliance</b> . . . . .	20	 <b>Transporting the appliance</b> . . . . .	42
Appliance overview . . . . .	20	 <b>Consumption values</b> . . . . .	43
Fascia . . . . .	21	Consumption values table . . . . .	43
Display . . . . .	22	 <b>Technical data</b> . . . . .	44
 <b>Overview of programmes</b> . . . . .	23	 <b>Disposal</b> . . . . .	44
 <b>Programme settings</b> . . . . .	25	 <b>Customer Service</b> . . . . .	45
 <b>Laundry</b> . . . . .	27		
Preparing laundry . . . . .	27		
Sorting laundry . . . . .	27		



## Intended use

- This appliance is intended for private domestic use only.
- Do not install or operate this appliance anywhere that is liable to experience frost and/or outdoor conditions. There is a risk that the appliance will be damaged if residual water in it freezes. If hoses freeze up, they may crack/burst.
- This appliance must only be used for drying and freshening up domestic laundry, consisting of items that have been washed with water and are suitable for tumble drying (see label on item). Using the appliance for any other purpose is outside of the scope of its intended application and is forbidden.
- This appliance is intended for use up to a maximum height of 4000 metres above sea level.

### Before you switch on the appliance:

Check that there is no visible damage to the appliance. Do not operate the appliance if it is damaged. Should you have any problems, please contact your specialist dealer or our customer service.

Read and follow the operating and installation instructions and all other information provided with this appliance.

Retain the documents for subsequent use or for subsequent owners.



## Safety instructions

The following safety information and warnings are provided to protect you from injury and to prevent material damage to your surroundings.

It is nevertheless important to take the necessary precautions and to proceed with care when installing, maintaining, cleaning and operating the appliance.

### Children/people/pets



#### Warning Risk of death!

Children and other people who are unable to assess the risks involved when using the appliance may injure themselves or may find themselves in life-threatening situations. Therefore please note:

- The appliance may be used by children over the age of 8 years and by persons with reduced physical, sensory or mental capacity or by persons with a lack of experience or knowledge as long as they are supervised or have received instruction on how to use the appliance safely and they have understood the potential risks of using the appliance.
- Children must not play with this appliance.

- Do not allow children to clean or maintain this appliance unsupervised.
- Keep children under 3 years and pets away from this appliance.
- Do not leave the appliance unattended when children or other people who are unable to assess the risks are in the vicinity.

 **Warning**  
**Risk of death!**

Children may lock themselves inside appliances and find themselves in a life-threatening situation.

- Do not position the appliance behind a door, as this may obstruct the appliance door or prevent it from opening completely.
- Once an appliance has reached the end of its life, pull the mains plug from the socket **before** severing the mains cable, and then destroy the lock on the appliance door.

 **Warning**  
**Risk of suffocation!**

If allowed to play with the packaging/plastic film or packing components, children may become caught in these or pull them over their heads and suffocate.

Keep packaging, plastic film and packing components away from children.

 **Warning**  
**Risk of poisoning!**

Detergents and care products may result in poisoning if consumed.

If accidentally swallowed, seek medical advice. Keep detergents and care products out of the reach of children.

 **Warning**  
**Eye/skin irritation!**

Contact with detergents or care products may cause eye/skin irritation.

Rinse eyes/skin thoroughly if they/it come(s) into contact with detergents or care products. Keep detergents and care products out of the reach of children.

## Installation

### **Warning**

#### **Risk of electric shock/fire/ material damage/damage to the appliance!**

If the appliance is not installed properly, this may lead to a dangerous situation. Ensure the following:

- The mains voltage on your power socket must match the rated voltage specified on the appliance (identification plate). The connected loads and the required fuse protection are specified on the identification plate.
- The appliance must not be supplied through an external switching device, such as a timer, or connected to a circuit that is regularly switched on and off by a utility.
- The mains plug and the protective contact socket must match and the earthing system must be correctly installed.
- The installation must have an adequate cross section.

- The mains plug must be freely accessible at all times. If this is not possible, in order to comply with the relevant safety regulations, a switch (all pole disconnection) must be built into the permanent installation in accordance with electrical installation regulations.
- If using a residual current circuit breaker, only use one that bears the following mark: . The presence of this mark is the only way to be sure that it fulfils all the applicable regulations.

### **Warning**

#### **Risk of electric shock/fire/ material damage/damage to the appliance!**

If the appliance's mains cable is altered or damaged, this may result in electric shock, short circuiting or fire due to overheating.

The mains cable must not be kinked, crushed or altered, and must not come into contact with any heat sources.

**⚠ Warning****Risk of fire/material damage/  
damage to the appliance!**

The use of extension cords or power strips may result in fire due to overheating or short circuiting.

Connect the appliance directly to an earthed socket that has been correctly installed. Do not use extension cords, power strips or multi-way couplers.

**⚠ Warning****Risk of injury/material  
damage/damage to the  
appliance!**

- The appliance may vibrate or move when in operation, potentially resulting in injury or material damage.  
Place the appliance on a clean, even, solid surface and, using a spirit level to guide you, level it with the screw-in feet.

- Incorrectly placing (stacking) this appliance on top of a washing machine may result in injury, material damage and/or damage to the appliance.  
If this appliance is to be placed on top of a washing machine, the washing machine must be of at least the same depth and width as the appliance, and it must be secured in place with the appropriate connection set if available. → *Page 16*  
The appliance **MUST** be secured with this connection set. Stacking the appliance in any other way is forbidden.
- If you take hold of any of the appliance's protruding parts (e.g. the appliance door) in order to lift or move it, these parts may break off and cause injury.  
Do not take hold of any of the appliance's protruding parts in order to move the appliance.

**⚠ Warning**

**Risk of injury!**

- The appliance is very heavy. Lifting it may result in injury. Do not lift the appliance on your own.
- The appliance has sharp edges on which you could cut your hands. Do not take hold of the appliance by its sharp edges. Wear protective gloves to lift it.
- If the hoses and mains cables are not correctly routed, they may constitute a tripping hazard, which may result in injury. Route hoses and cables such that they do not constitute a tripping hazard.

**Operation**

**⚠ Warning**

**Risk of explosions/fire!**

Laundry that has come into contact with solvents, oil, wax, wax remover, paint, grease or stain remover may ignite when dried in the machine, or even cause the appliance to explode. Therefore please note:

- Rinse the laundry thoroughly with warm water and detergent before drying it in the machine.
- Do not place laundry in this appliance to be dried if the laundry has not been washed first.

- Do not use the appliance if industrial chemicals have been used to clean the laundry.

**⚠ Warning**

**Risk of explosions/fire!**

- If there is any residual material left in the fluff filter, this may ignite when drying is in progress, or even cause the appliance to catch fire or explode. Clean the fluff filter regularly.
- Certain objects may ignite when drying is in progress, or even cause the appliance to catch fire or explode. Remove any lighters or matches from pockets on items of clothing.
- If there is coal dust or flour in the air around the appliance, this may cause an explosion. Make sure that the area around the appliance is kept clean when it is in operation.

**⚠ Warning**

**Risk of fire/material damage/ damage to the appliance!**

The appliance contains R290, a refrigerant that is environmentally friendly but flammable. Keep open fire and ignition sources away from the appliance.



**⚠ Warning****Risk of fire/material damage/  
damage to the appliance!**

If a program is terminated before the drying cycle has finished, this prevents the laundry from cooling down sufficiently and may cause the laundry to ignite, or may result in material damage or damage to the appliance.

- During the last part of the drying cycle, the laundry in the drum is not heated (cooling cycle). This is to ensure that it remains at a temperature at which it will not be damaged.
- Do not switch off the appliance before the drying cycle has finished unless you remove all items of laundry from the drum immediately and spread them out (to dissipate the heat).

**⚠ Warning****Risk of poisoning/material  
damage!**

Condensation water is not suitable for drinking and may be contaminated with lint. Contaminated condensation water may be hazardous to health and may cause material damage.

Do not drink or reuse.

**⚠ Warning****Risk of poisoning!**

Poisonous fumes may be given off by cleaning agents that contain solvents, e.g. cleaning solvent.

Do not use cleaning agents that contain solvents.

**⚠ Warning****Risk of injury!**

- If you support your weight/sit on the appliance door when it is open, the appliance may tip over, which may result in injury.  
Do not support your weight on the appliance door when it is open.
- If you climb onto the appliance, the worktop may break, which may result in injury.  
Do not climb onto the appliance.
- If you reach into the drum while it is still rotating, you risk injuring your hands.  
Wait until the drum has stopped rotating.

## Caution!

### Material damage/damage to the appliance

- If the amount of laundry in the appliance exceeds its maximum load capacity, it may not be able to operate properly, or this may result in material damage or damage to the appliance.  
Do not exceed the maximum load capacity of dry laundry. Make sure you comply with the maximum load capacities specified for each of the programs. → *Page 23*
- If you operate the appliance without a fluff catcher (e.g. fluff filter, fluff depot, depending on appliance specifications), or if the fluff catcher is incomplete or defective, this may result in damage to the appliance.  
Do not operate the appliance without a fluff catcher, or with a fluff catcher that is incomplete or defective.
- Light objects such as hair and lint may be sucked into the air inlet when the appliance is in operation. Keep these away from the appliance.
- Foam and foam rubber may deform or melt if dried in the appliance.  
Do not dry laundry items that contain foam or foam rubber in the appliance.

- If you pour the wrong quantity of detergent or cleaning agent into the appliance, this may result in material damage or damage to the appliance.  
Use detergents/care products/cleaning agents and softeners in accordance with the manufacturers' instructions.
- If the appliance overheats, it may not be able to operate properly, or this may result in material damage or damage to the appliance.  
Make sure that the appliance's air inlet is never obstructed when the appliance is in operation, and that the area around the appliance is adequately ventilated.

## Cleaning/Maintenance

### **Warning** **Risk of death!**

The appliance is powered by electricity. There is a risk of electric shock if you come into contact with live components. Therefore please note:

- Switch off the appliance. Disconnect the appliance from the power supply (pull out the plug).
- Never take hold of the mains plug with wet hands.

- When removing the mains plug from the socket, always take hold of the plug itself and never the mains cable, otherwise this may damage the mains cable.
- Do not make any technical modifications to the appliance or its features.
- Repairs and any other work on the appliance must only be conducted by our customer service or by an electrician. The same applies for replacing the mains cable (when necessary).
- Spare mains cables can be ordered from our customer service.

### **Warning**

#### **Risk of poisoning!**

Poisonous fumes may be given off by cleaning agents that contain solvents, e.g. cleaning solvent.

Do not use cleaning agents that contain solvents.

### **Warning**

#### **Risk of electric shock/material damage/damage to the appliance!**

If moisture penetrates the appliance, this may cause it to short circuit.

Do not use a pressure washer, steam cleaner, hose or spray gun to clean your appliance.

### **Warning**

#### **Risk of injury/material damage/damage to the appliance!**

The use of spare parts and accessories supplied by other brands is dangerous and may result in injury, material damage or damage to the appliance.

For safety reasons, use genuine spare parts and accessories only.

### **Caution!**

#### **Material damage/damage to the appliance**

Cleaning agents and agents for pretreating laundry (e.g. stain removers, prewash sprays, etc.) may cause damage if they come into contact with the surfaces of the appliance. Therefore please note:

- Do not allow these agents to come into contact with the surfaces of the appliance.
- Clean the appliance with nothing but water and a soft, damp cloth.
- Remove any detergent, spray or other residues immediately.

## Energy-saving tips

- Spin the laundry before drying. The drier the laundry, the shorter the programme will be, in turn reducing energy consumption.
- Load the appliance with the maximum loads permitted for the programmes.

**Note:** If the maximum load is exceeded, this extends the programme duration and increases energy consumption.

- Operate the appliance in a ventilated room and make sure that the air inlet on the appliance is unobstructed so that air exchange can take place unhindered.
- Regularly remove the fluff from the appliance. If there is fluff in the appliance, this extends the programme duration and increases energy consumption.
- If you do not perform any actions on the appliance for an extended period before the programme starts or once the programme has ended, the appliance will automatically switch to energy-saving mode. The display and indicator lights go out after a few minutes and **Start/Pause**  flashes. To end energy-saving mode, all you need to do is perform an action on the appliance, such as opening and closing the door.
- If you do not perform any actions on the appliance for an extended period when it is in energy-saving mode, the appliance automatically switches itself off.

## Installing and connecting the appliance

### Scope of supply

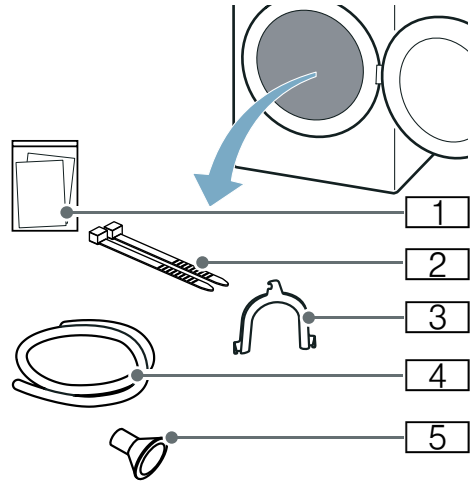

- 1 Accompanying documents (e.g. installation and operating instructions)
- 2 Fastening parts
- 3 U-piece for fixing the drain hose in place
- 4 Drain hose
- 5 Connection adapter

1. Remove any packaging and protective covers completely from the appliance.
2. Open the door.
3. Remove all the accessories from the drum.

You can now install and connect the appliance.

### Caution!

#### Risk of material damage and damage to the appliance

Objects remaining in the drum that are not designed for operation with the appliance may result in material damage and damage to the appliance. Remove these objects, along with all accessories, from the drum.

## Installing the appliance

### Warning

#### Risk of death!

Children may lock themselves inside appliances and find themselves in a life-threatening situation.

- Do not position the appliance behind a door, as this may obstruct the appliance door or prevent it from opening completely.
- Once an appliance has reached the end of its life, pull the mains plug from the socket **before** severing the mains cable, and then destroy the lock on the appliance door.

### Warning

#### Risk of explosions/fire!

If there is coal dust or flour in the air around the appliance, this may cause an explosion.

Make sure that the area around the appliance is kept clean when it is in operation.

### Warning

#### Risk of fire/material damage/damage to the appliance!

The appliance contains R290, a refrigerant that is environmentally friendly but flammable. Keep open fire and ignition sources away from the appliance.



### Warning

#### Risk of injury/material damage/damage to the appliance!

- The appliance may vibrate or move when in operation, potentially resulting in injury or material damage.  
Place the appliance on a clean, even, solid surface and, using a spirit level to guide you, level it with the screw-in feet.
- Incorrectly placing (stacking) this appliance on top of a washing machine may result in injury, material damage and/or damage to the appliance.  
If this appliance is to be placed on top of a washing machine, the washing machine must be of at least the same depth and width as the appliance, and it must be secured in place with the appropriate connection set if available.  
→ Page 16  
The appliance **MUST** be secured with this connection set. Stacking the appliance in any other way is forbidden.
- If you take hold of any of the appliance's protruding parts (e.g. the appliance door) in order to lift or move it, these parts may break off and cause injury.  
Do not take hold of any of the appliance's protruding parts in order to move the appliance.

**en** Installing and connecting the appliance



### **Warning**

#### **Risk of injury!**

- The appliance is very heavy. Lifting it may result in injury. Do not lift the appliance on your own.
- The appliance has sharp edges on which you could cut your hands. Do not take hold of the appliance by its sharp edges. Wear protective gloves to lift it.

### **Caution!**

#### **Material damage/damage to the appliance**

If the appliance overheats, it may not be able to operate properly, or this may result in material damage or damage to the appliance.

Make sure that the appliance's air inlet is never obstructed when the appliance is in operation, and that the area around the appliance is adequately ventilated.

### **Caution!**

#### **Risk of material damage and damage to the appliance**

The appliance underwent a function test before leaving the factory and therefore may contain residual water. This residual water may leak out if the appliance is tilted at an angle greater than 40°.

### **Install the appliance as follows:**

1. Place the appliance on a clean, even, solid surface.
2. Check that the appliance is level using a spirit level.

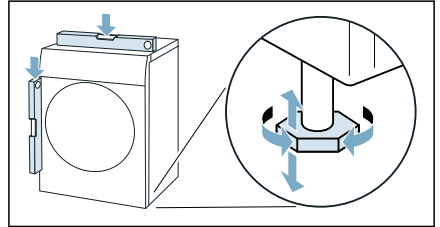

3. If necessary, turn the appliance feet to make sure it is level.

You can now connect the appliance.

### **Notes**

- All appliance feet must stand firmly on the ground.
- If appliances are not aligned correctly, this may result in noises, vibrations, uneven drum operation and/or to residual water leaking out of the appliance.

## Connecting the appliance

### **Warning**

#### **Risk of electric shock/fire/material damage/damage to the appliance!**

If the appliance is not installed properly, this may lead to a dangerous situation. Ensure the following:

- The mains voltage on your power socket must match the rated voltage specified on the appliance (identification plate). The connected loads and the required fuse protection are specified on the identification plate.
- The appliance must not be supplied through an external switching device, such as a timer, or connected to a circuit that is regularly switched on and off by a utility.
- The mains plug and the protective contact socket must match and the earthing system must be correctly installed.
- The installation must have an adequate cross section.
- The mains plug must be freely accessible at all times. If this is not possible, in order to comply with the relevant safety regulations, a switch (all pole disconnection) must be built into the permanent installation in accordance with electrical installation regulations.
- If using a residual current circuit breaker, only use one that bears the following mark: . The presence of this mark is the only way to be sure that it fulfils all the applicable regulations.

### **Warning**

#### **Risk of electric shock/fire/material damage/damage to the appliance!**

If the appliance's mains cable is altered or damaged, this may result in electric shock, short circuiting or fire due to overheating.

The mains cable must not be kinked, crushed or altered, and must not come into contact with any heat sources.

### **Warning**

#### **Risk of fire/material damage/damage to the appliance!**

The use of extension cords or power strips may result in fire due to overheating or short circuiting. Connect the appliance directly to an earthed socket that has been correctly installed. Do not use extension cords, power strips or multi-way couplers.

### **Warning**

#### **Risk of injury!**

If the hoses and mains cables are not correctly routed, they may constitute a tripping hazard, which may result in injury.

Route hoses and cables such that they do not constitute a tripping hazard.

## Connect the appliance as follows:

1. Connecting the drain hose.  
→ Page 33

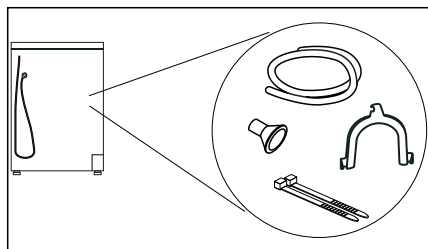

2. Plug the appliance's mains plug into the designated socket.
  3. Check that the mains plug is in securely.
- Your appliance is now ready to use.

### Caution!

#### Risk of material damage/damage to the appliance

The appliance contains refrigerant and may be damaged if it is operated immediately after transportation. Allow the appliance to rest for two hours before initial use.

**Note:** If in doubt, have your appliance connected by a qualified professional.

## Before using the appliance for the first time

### Before you switch on the appliance:

Check that there is no visible damage to the appliance. Do not operate the appliance if it is damaged. Should you have any problems, please contact your specialist dealer or our customer service.

**Note:** Once the appliance has been properly installed and connected, it is ready to use. No further steps are necessary.

## Optional accessories

Order optional accessories\* from the after-sales service:

- **Basket for woollens:**  
Dry or air individual woollen items, sports shoes and soft toys in the basket for woollens.  
– Order number: **WMZ20600**.
- **Platform:**  
For easier loading and unloading, raise your dryer with a platform. You can transport laundry with the laundry basket integrated into the platform drawer.  
– Order number: **WMZ20500**.
- **Washer-dryer stack connection kit:**  
To save space, the dryer can be placed on top of a suitable washing machine of the same width and depth.  
Only this connection kit may be used to secure the dryer to the washing machine.  
– Order number with pull-out worktop: **WTZ11400**  
– Order number without pull-out worktop: **WTZ20410**.
- **Condensate drainage kit:**  
You can discharge the condensation water into the waste-water system via a drain hose. If you choose to discharge the condensation water into the waste-water system, you will not need to empty the condensation container during the drying programme or after each time you use the dryer.  
– Order number: **WTZ1110**

\* Depending on the appliance features

## Appliance settings

### Childproof lock

Activating the childproof lock prevents the settings from being accidentally changed on the control panel.

#### Activating/deactivating the childproof lock:

- Press and hold **Child Lock**  **3 sec.** for 3 seconds.

**Note:** The childproof lock will remain active, even once the appliance has been switched off. If you wish to change settings on the control panel when you turn on the appliance, you will need to deactivate the childproof lock.

### Activating setting mode

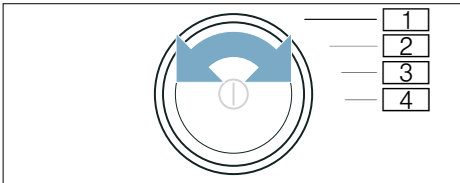

In order to apply the settings described below, you will first need to activate setting mode. The options on the programme selector that will allow you to do this are as follows:

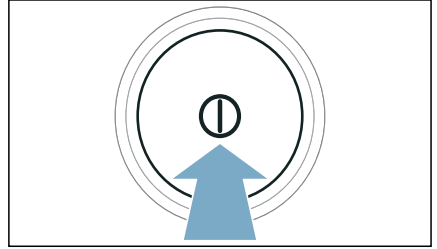

- 1 Activate **setting mode**
- 2 Activate **setting mode** and adjust **audible notification signal** volume
- 3 Adjust the **audible button signal** volume
- 4 **Automatic switch-off** function

1. Switch on the appliance.



2. Turn the programme selector to position 1.
3. Press **Fine Adjust**  and, at the same time, turn the programme selector to position 2.
4. Release **Fine Adjust** . Setting mode is now activated.

### Changing the audible signal volume

You can adjust the volume of audible notification signals (that indicate that a programme has ended, for example) and audible button signals by turning the rotary selector to the following positions:

- 2: Audible notification signal volume
- 3: Audible button signal volume

1. Activate setting mode.
2. Turn the programme selector to the required position.
3. Use the **Finished in**  **+** or **-** button to set the volume you require (0 = off; 4 = very loud).

### Switching the automatic switch-off function on/off

If the appliance is not used for an extended period, it may automatically switch itself off until a programme starts or when a programme has ended in order to save energy. It can be switched back on again at any time by pressing ①.

You can switch the appliance's automatic switch-off function on or off as follows:

1. Activate setting mode.
2. Turn the programme selector to position 4.
3. Use the **Finished in** ⌚ + or – button to switch the appliance's automatic switch-off function on or off.

### Exiting setting mode

Once you have applied all the settings, press ① to switch off the appliance.

The settings you have selected will be saved and will take effect the next time the washing machine is switched on.

## Quick reference guide

**Note:** The appliance must be correctly installed and connected. → *Page 12*

**1**

**Before starting the programme:**

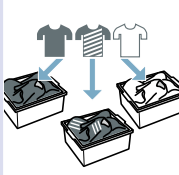
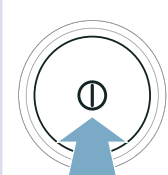
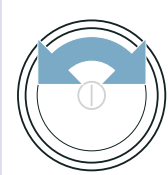





Sort the laundry.

Switch on the appliance.

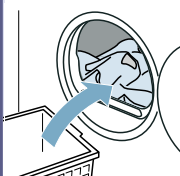
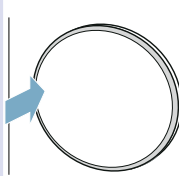
Select a programme.

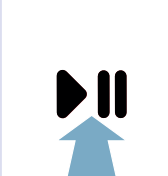
**2**

Open the door and place the laundry in the drum.



Close the door.

If necessary: Adjust the programme settings.

Start the programme.

**3**

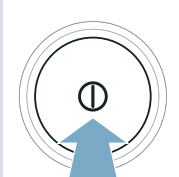
**Once the programme has ended:**

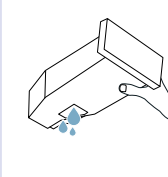



Switch off the appliance.

Open the door and remove the laundry.

Empty the condensation container.

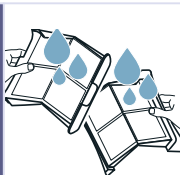
**4**



Remove the fluff.

## Familiarising yourself with your appliance

### Appliance overview

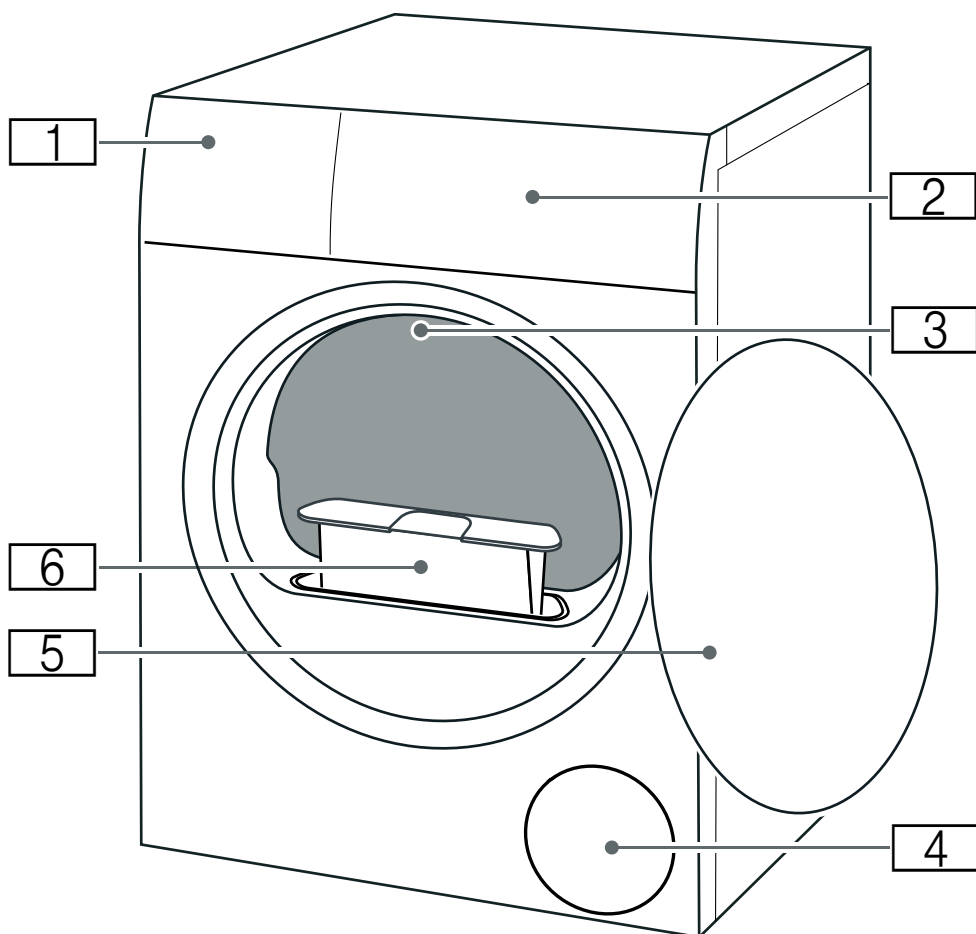

- 1** Condensation container
- 2** Control panel
- 3** Drum interior lighting (depending on the model)
- 4** Air inlet
- 5** Door
- 6** Fluff filter

## Fascia

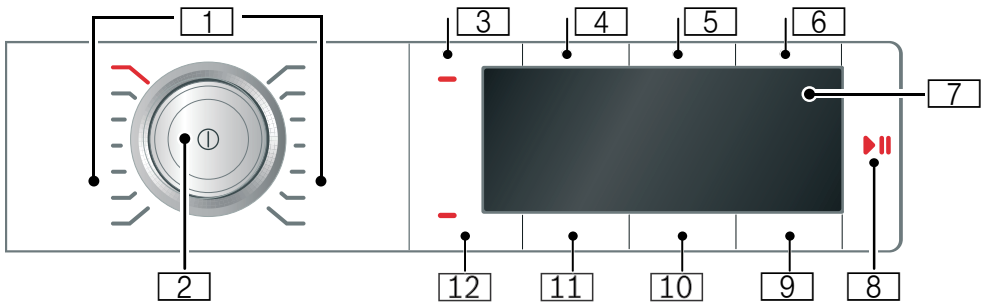

**1** Programmes → *Page 23*

**2** Programme selector

- Press to switch the appliance on/off
- Turn to set a programme

**3** Childproof lock

Prevents the functions you have set from being changed accidentally.  
To activate/deactivate it: → *Page 17*

**4** Anti-Crease 60 min

**5** Anti-Crease 120 min

**6** Low-Heat Drying

**7** Display

Displays settings and information

**8** ▶|| for:

- Starting a programme
- Pausing a programme, e.g. to add items of laundry
- Cancelling a programme

**9** Ready in









**10** Degree of dryness







**11** Dryness level

**12** Audible signal

















## Overview of programmes

Programme	Maximum load
<b>Programme name</b> Brief explanation of the programme and the items for which it is suitable.	<b>Maximum load based on the dry weight of the items</b>
<b>Cottons</b>  Hard-wearing items and heat-resistant items made of cotton or linen.	<b>9 kg</b>
<b>Synthetics</b>  Items made of synthetic or blended fabrics.	<b>3.5 kg</b>
<b>Mix</b>  Mixed load consisting of items made from cotton and synthetic fabrics.	<b>3 kg</b>
<b>Delicates</b>  Delicate, washable items, e.g. made from satin, or synthetic or blended fabrics.	<b>2 kg</b>
<b>Wool Finish</b>  Machine-washable items made of wool or containing wool.	<b>0.5 kg</b>
<b>Notes</b> <ul style="list-style-type: none"> <li>■ Laundry becomes fluffier but not dry.</li> <li>■ Remove laundry once the programme has ended and allow to dry.</li> </ul>	
<b>Timed Progr. Cold</b>  Timed programme for all types of fabric except for wool and silk. For freshening up or airing clothing that has hardly been worn. <b>Note:</b> You can adjust the programme duration. → "Programme settings" on page 25	<b>3 kg</b>
<b>Timed Progr. Warm</b>  Timed programme for all types of fabric except silk. Suitable for pre-dried or slightly damp laundry and for drying off multi-layered, thick laundry. <b>Notes</b> <ul style="list-style-type: none"> <li>■ Dry woollens, sports shoes and soft toys only with the basket for woollens.</li> <li>■ In the timed programme, the laundry's remaining moisture is not automatically detected. If the laundry is still too damp when the drying programme has ended, repeat the programme and, if required, extend the programme duration.                → "Programme settings" on page 25</li> </ul>	<b>3 kg</b> <b>Max. load for woollens/soft toys in the basket: 1 basket load</b> <b>Max. load for shoes in the basket: 1 pair</b>
<b>Shirts/Blouses</b>  Shirts/blouses made of cotton, linen, or synthetic or blended fabrics. <b>Note:</b> Once the laundry is dry, iron it or hang it up. This will allow the residual moisture to be distributed evenly.	<b>1.5 kg</b>

<p><b>Duvet</b> </p> <p>Clothing, pillows, quilts or bedspreads filled with synthetic fibres.</p> <p><b>Note:</b> Dry large items individually. Follow the instructions on the care label.</p>	<b>2.5 kg</b>
<p><b>Down Wear</b> </p> <p>Clothing, bedspreads or eiderdowns stuffed with down.</p> <p><b>Notes</b></p> <ul style="list-style-type: none"> <li>■ Dry large items individually.</li> <li>■ Once the programme has ended, shake the items of laundry to distribute the stuffing and eliminate any pockets of moisture. Restart the programme if necessary.</li> </ul>	<b>1.5 kg</b>
<p><b>Sportswear</b> </p> <p>Weatherproof and outdoor clothing with a membrane coating and water-repellent fabrics.</p>	<b>1.5 kg</b>
<p><b>Towels</b> </p> <p>Hard-wearing towels and dressing gowns made of cotton.</p>	<b>6 kg</b>
<p><b>Super Quick 40'</b> </p> <p>Mixed load of synthetic fabrics and light cottons.</p>	<b>2 kg</b>
<p><b>AllergyPlus</b> </p> <p>Hard-wearing items.</p> <p><b>Note:</b> The programme reaches high temperatures. Particularly suitable for strict hygiene requirements.</p>	<b>4 kg</b>

## P+ Programme settings

Buttons	Displays	Explanations and information
<b>Note:</b> Not all buttons and their functions can be selected in all programmes.		
<b>Easy Iron 60'</b> 		The drum moves the laundry at regular intervals after drying to prevent creasing. You can extend the automatic Anti-Crease function by 60 minutes (by pressing <b>Easy Iron 60'</b>  ) or 120 minutes (by pressing <b>Easy Iron 120'</b>  ) after any programme has finished.
<b>Easy Iron 120'</b> 		
<b>Low Heat</b> 		Reduced temperature for delicate fabrics, e.g. polyacrylic or elastane; may increase the drying time.
<b>End Signal</b> 		Use the End Signal  ) button to activate or deactivate the audible signal that sounds to indicate that the programme has ended. If the setting has been selected, the button's indicator light will be lit and the signal tone is activated.
<b>Drying Target</b> 		Select the dryness level depending on the required degree of dryness.  If you have selected a dryness level, this will be stored for the selected programme even after the appliance has been switched off. Exception: The settings will not be saved for Cottons.
Cupboard dry plus		Multi-layered, thick laundry that does not dry readily.
Cupboard dry		Normal, single-layered laundry.
Iron Dry		Normal, single-layered laundry that still needs to be damp after drying and is suitable for ironing or hanging up.
<b>Fine Adjust</b> 		If you think the laundry is still too damp when the drying programme has ended, you can adjust the degree of dryness to achieve a particular dryness level. To increase the dryness level, set the degree of dryness to between  and  . This will extend the programme duration but the temperature will remain the same.  Once you have adjusted the degree of dryness for a programme, this setting will be retained for the programme even after the appliance has been switched off.

Finished in ⌚

1-24

**Before starting the programme**, you can preselect the programme end time ("Ready in" time) in hourly increments (h = hour), up to a maximum of 24 hours:

1. Select a programme.  
The programme duration will be displayed for the selected programme, e.g. **1:45** (hours:minutes).
2. Press **Finished in** ⌚ repeatedly until the required number of hours is displayed.

**Note:** Use the **Finished in** ⌚ + button to increase the setting values, and the **Finished in** ⌚ – button to reduce them.

3. Press **Start/Pause** ▷⏸.

This activates the time delay.

Before the programme starts, the selected number of hours (e.g. **3**) is shown on the display and counts down until the drying programme starts. The duration of the programme will then be displayed.

**Note:** The programme duration is included in the "Ready in" time.

E.g.  
⌚ 0:40

The drying time for **timed programmes** can be extended to up to 3 hours 30 minutes in 10-minute increments.



## Laundry

### Preparing laundry

#### **Warning**

#### **Risk of explosions/fire!**

Certain objects may ignite when drying is in progress, or even cause the appliance to catch fire or explode. Remove any lighters or matches from pockets on items of clothing.

#### **Caution!**

#### **Risk of damage to the drum and laundry**

Leaving objects in the pockets of your clothing can cause damage to the drum and laundry when the appliance is in operation. Remove all objects (e.g. metal items) from clothing pockets.

Prepare the laundry as follows:

- Tie cloth belts, apron strings, etc. together or use a laundry bag.
- Close zips, hooks, eyelets and buttons. Button up large items of laundry, such as covers.
- Always dry very small items of laundry, e.g. babies' socks, together with large items such as towels.
- Use timed programmes for single items.
- Knitted items, such as T-shirts and jerseys, often shrink slightly the first time they are tumble-dried. Use a gentle programme.
- Do not overdry easy-care laundry. This leads to increased creasing of your laundry.
- Some detergents and care products, e.g. starch or softeners, contain particles that may accumulate on the moisture sensor. This may impair the sensor's performance and, in turn, the drying result.

#### **Notes**

- When washing laundry to be tumble-dried, use the correct amount of detergent and care products as specified in the manufacturer's instructions.
- Clean the moisture sensor regularly → *Page 37*.

### Sorting laundry

**Note:** Load the laundry item by item into the appliance. For more effective drying, do not stuff an entire bundle of laundry into the dryer at once.

#### **Caution!**

#### **Risk of material damage to the dryer or laundry**

Laundry that is unsuitable for tumble-drying may damage the appliance and the laundry when it is dried. Before you dry it, sort the laundry according to the information given on the care label:

- Suitable for tumble drying
- Dry at normal temperature
- Dry at low temperature
- Do not tumble-dry

When sorting the laundry to be dried, take the following points into account:

- To achieve an even drying result, only dry laundry of the same type of fabric and texture together. If you dry thin, thick and multi-layered fabrics together, they will dry to differing degrees.
- Use the fabric descriptions given for the individual drying programmes to help you choose the most appropriate programme.  
→ "Overview of programmes" on page 23

**Note:** You can select a timed programme to add extra drying time for laundry that is still damp.

**Caution!**  
**Risk of material damage to the appliance and laundry**

Do **not** tumble-dry the following items or fabrics in the appliance:

- Laundry contaminated with solvents, wax or grease.
- Unwashed items.
- Items made from non-breathable fabrics (e.g. rubber-coated).
- Items made from delicate fabrics, such as silk and curtains made of synthetic material.



## Operating the appliance

### Loading laundry and switching on the appliance

**Note:** The appliance must be correctly installed and connected. → Page 12

1. Prepare and sort the laundry.
2. Press  to switch on the appliance.

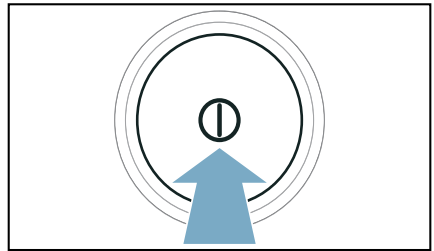

3. Open the door.  
Check that the drum has been completely emptied. Empty it if necessary.

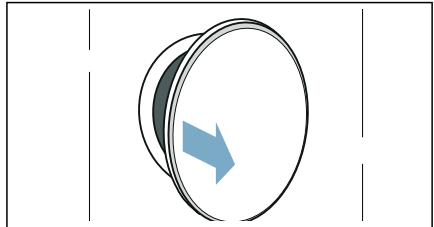

4. Load the laundry unfolded into the drum.

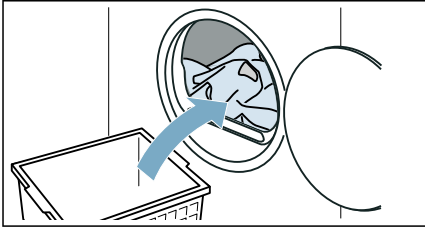

5. Close the appliance door.

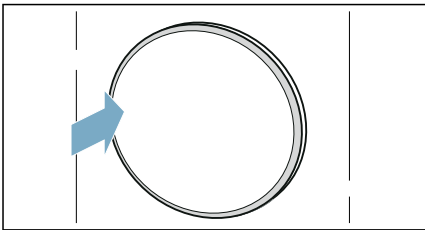

**Caution!**

**Risk of material damage to the appliance or laundry.**

Make sure that laundry is not trapped in the door.

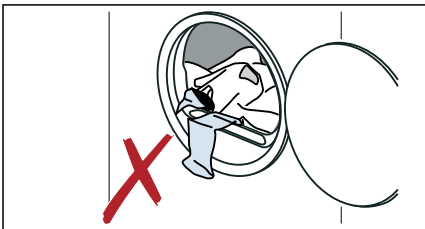

**Note:** The appliance's drum is lit up after the door is opened and closed and once the programme has started. The drum's interior light goes out on its own.

## Setting a programme

**Note:** If you have activated the childproof lock, you must deactivate it before you can set a programme.  
→ Page 17

1. Set the programme you require.

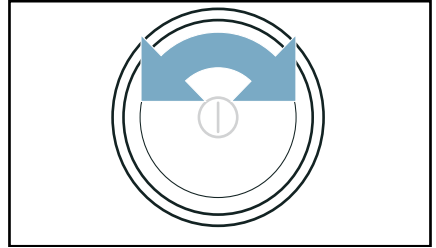

The programme settings will appear on the display.

2. Adjust the programme settings, if required.  
→ "Programme settings" on page 25

## Starting the programme

Press **Start/Pause** .

**Note:** If you want to prevent the programme from being adjusted inadvertently, activate the childproof lock. → Page 17



## Programme progress

The programme status will be indicated on the display.

**Note:** When a programme is selected, the expected drying time for the maximum permitted load is displayed. The moisture sensor measures the residual moisture in the laundry as it is being dried. The programme duration and the remaining time indicated on the display are automatically adjusted as the programme progresses, depending on how damp the laundry is (exception: Timed programmes).

## Changing the programme or adding more laundry

You can remove or add laundry and change or adjust the programme at any time during drying.

1. Open the door or press **Start/Pause**  to pause the programme.
2. Add or remove laundry.
3. If required, select a different programme or a different programme setting.  
→ "Overview of programmes" on page 23  
→ "Programme settings" on page 25
4. Close the appliance door.
5. Press **Start/Pause** .

**Note:** The programme duration is updated on the display, depending on the load and on the residual moisture in the laundry. The values displayed may change when the programme or load is changed.

## Cancelling the programme

The programme can be cancelled at any time by opening the door or pressing **Start/Pause** .

### Caution!

**Risk of fire. Laundry may catch fire.**

If you cancel the programme, remove all items of laundry from the dryer and spread them out to allow the heat to dissipate.

## End of programme

-  - appears in the display.

## Removing laundry and switching off the appliance

1. Remove the laundry.

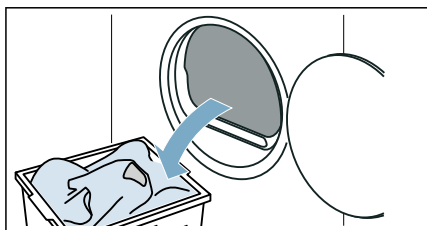

2. Press  to switch off the appliance.

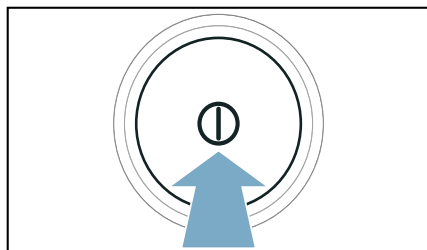

## Emptying the condensation container

Condensation will form in the appliance as it dries the laundry.

If there is no drain hose connected to the appliance, the condensation water from the appliance will run into the condensation container. In this case, you will need to empty the condensation container each time the dryer finishes drying the laundry, and also if it becomes full before drying is complete.

1. Pull out the condensation container horizontally.

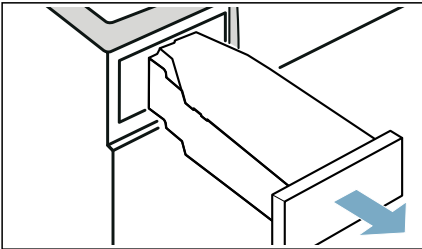

2. Pour out the condensation water.

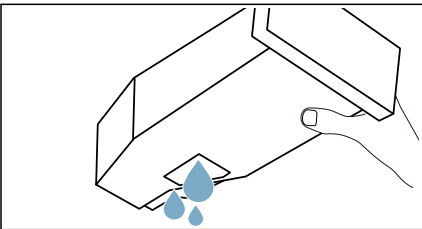

### Caution!

#### Risk of harm to health and material damage

Condensation water is not suitable for drinking and may be contaminated with fluff. Contaminated condensation water may be harmful to your health and cause material damage. Do not drink the condensation water or reuse it.

3. Push the condensation container back into the appliance until you feel it lock into place.

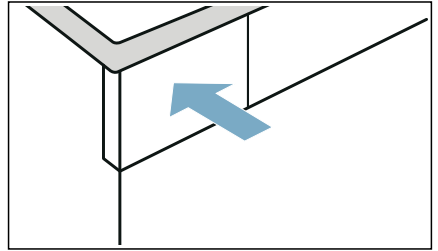

**Note:** The filter in the condensation container filters the condensation water, which is used during the appliance's automatic cleaning cycle. The filter is cleaned by emptying out the condensation water. You should still check the filter regularly for any build-up, and remove this if necessary.  
→ "Cleaning the filter in the condensation container" on page 38

## Removing the fluff

**Note:** During drying, fluff and hair from the laundry is trapped by the fluff filter. If the fluff filter is clogged or dirty, this reduces the flow of air, preventing the appliance from achieving optimal drying results. Dirty fluff filters increase the power consumption and increase the required drying time.

### Clean the fluff filter after each drying cycle:

1. Open the door and remove all fluff from it.
2. Pull out the two-part fluff filter.

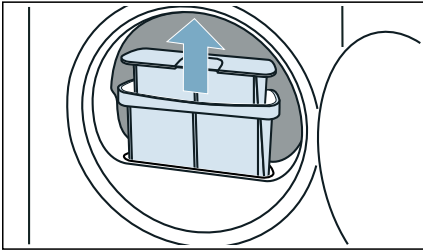

3. Remove the fluff from the fluff filter recess. Ensure that no fluff falls into the open shaft.

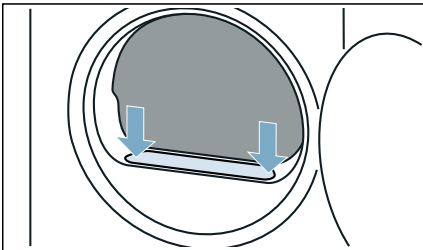

4. Pull the two-part fluff filter apart.

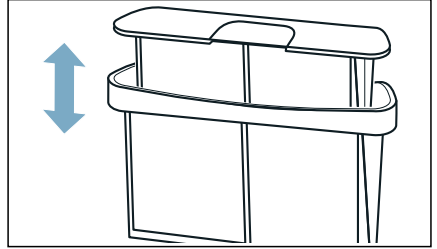

5. Open the two parts of the filter.

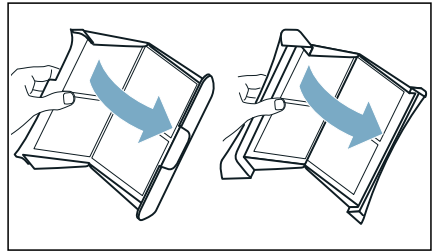

6. Remove all fluff from both parts of the filter.

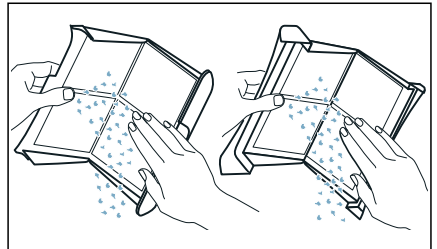

7. Rinse off fluff under warm, running water.

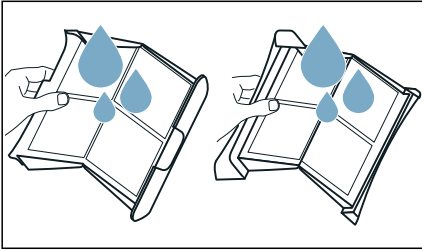

8. Dry the two parts of the fluff filter, snap them shut and reinsert the filter.

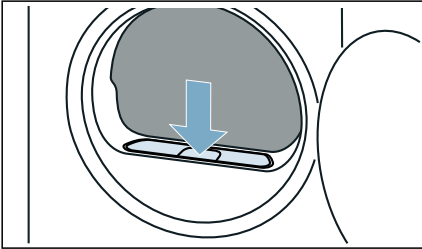

**Caution!**  
**Material damage/damage to the appliance**

If you operate the appliance without a fluff catcher (e.g. fluff filter, fluff depot, depending on appliance specifications), or if the fluff catcher is incomplete or defective, this may result in damage to the appliance.  
Do not operate the appliance without a fluff catcher, or with a fluff catcher that is incomplete or defective.



## Draining the condensation water

Condensation will form in the appliance as it dries the laundry.

You must ensure that the drain hose is connected when you operate the appliance.

If there is no drain hose connected to the appliance, the condensation water from the appliance will run into the condensation container. In this case, you will need to empty the condensation container each time the dryer finishes drying the laundry, and also if it becomes full before drying is complete.

**Connect the drain hose as follows:**

1. Remove any accessories from the drum.

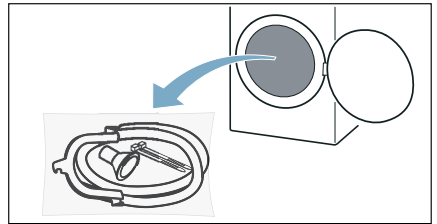

2. Remove all items from the bag.

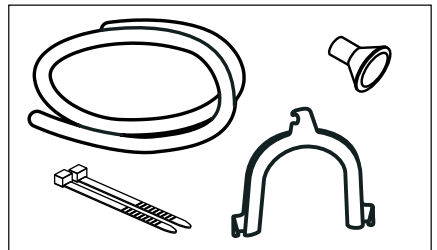

**en** Draining the condensation water

3. Detach the condensation hose from the socket.

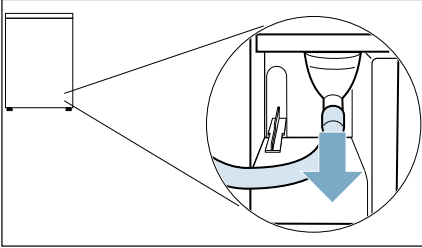

**Note:** The appliance comes delivered with the condensation hose already fitted to the socket.

4. Place the condensation hose in the "parked" position.

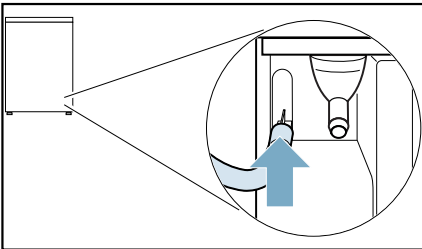

5. Take the drain hose from the accessories and attach it to the free socket, pushing it up to the stop.

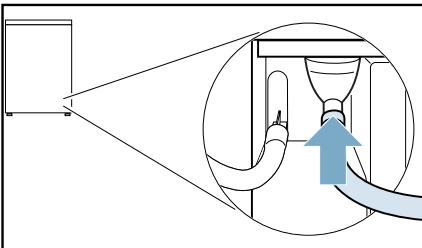

6. Secure the other side of the drain hose using the remaining accessories, depending on the connection situation.

**Washbasin:**

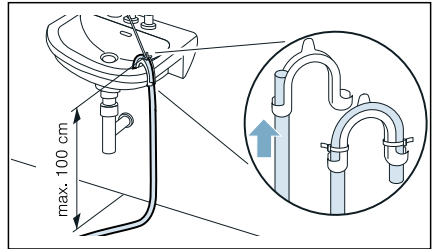

**Siphon:**

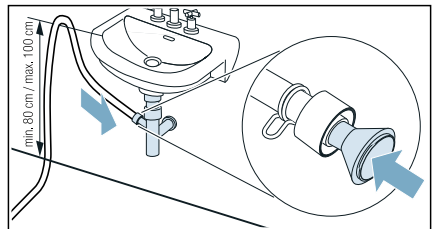

The connection point must be secured using a hose clamp (12-22 mm clamping range, available from specialist retailers). When connecting to a siphon, make sure that the drain hose is routed at a height of at least 80 cm, but no more than 100 cm.

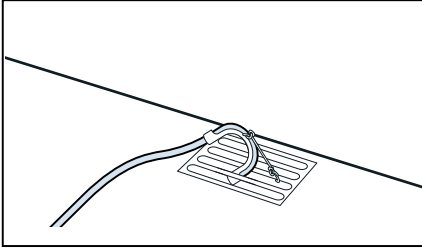
**Floor drain:****Caution!****Risk of material damage due to leaks or draining water.**

Secure the drain hose to prevent it from slipping out. Do not kink or bend the drain hose. The height difference between the surface on which the appliance is installed and the drain hose must be no more than 100 cm.

**Caution!****Risk of accumulated water being drawn back into the appliance and causing material damage.**

Check that the water drains away quickly. The drain must not be sealed or blocked.

7. Pull out the condensation container horizontally and empty it.

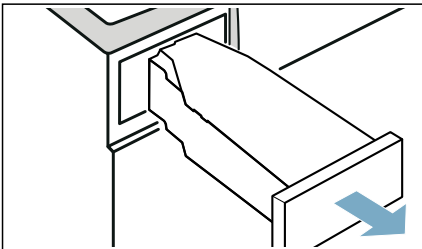

8. Turn the condensation container 180° onto its underside and remove the stopper that is fitted.

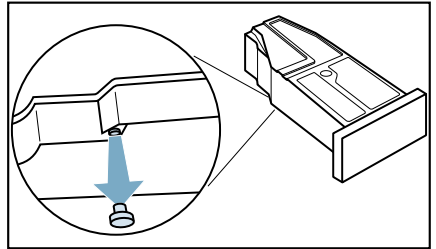

9. Turn the condensation container 180° again and insert the stopper into the recess in the top of the condensation container.

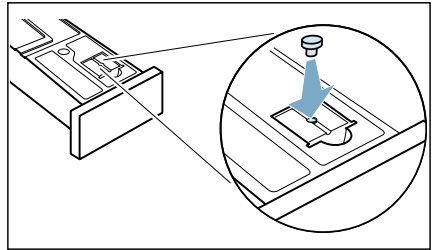

10. Pull the filter out of its snap-in lock.

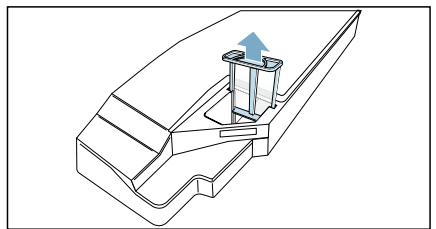

11. Place the filter into the recess on the condensation container.

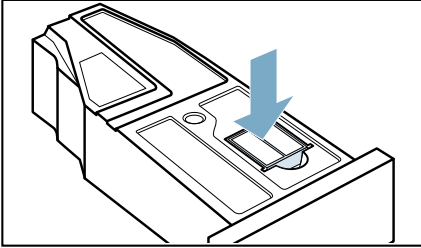

12. Slide in the condensation container until it clicks into place.

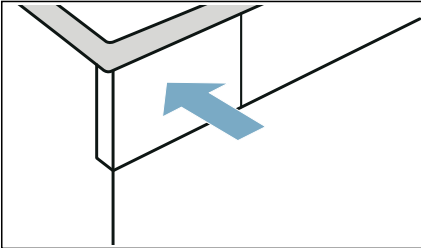

The condensation water is now discharged via the drain hose into the waste-water system or into a washbasin.

**Note:** If you want to drain the condensation water back into the condensation container, reverse these steps.

**Caution!**  
**Risk of material damage/damage to the appliance**

If you are draining condensation water into the condensation container, liquid may leak out of the socket and cause material damage. Before operating the appliance, make sure that the condensation hose is secured to the socket.



## Cleaning and maintenance

### Cleaning the appliance

**Warning**  
**Risk of death!**

The appliance is powered by electricity. There is a risk of electric shock if you come into contact with live components. Therefore please note:

- Switch off the appliance. Disconnect the appliance from the power supply (pull out the plug).
- Never take hold of the mains plug with wet hands.
- When removing the mains plug from the socket, always take hold of the plug itself and never the mains cable, otherwise this may damage the mains cable.
- Do not make any technical modifications to the appliance or its features.
- Repairs and any other work on the appliance must only be conducted by our customer service or by an electrician. The same applies for replacing the mains cable (when necessary).
- Spare mains cables can be ordered from our customer service.

**Warning**  
**Risk of poisoning!**

Poisonous fumes may be given off by cleaning agents that contain solvents, e.g. cleaning solvent. Do not use cleaning agents that contain solvents.

**⚠ Warning****Risk of electric shock/material damage/damage to the appliance!**

If moisture penetrates the appliance, this may cause it to short circuit. Do not use a pressure washer, steam cleaner, hose or spray gun to clean your appliance.

**Caution!****Material damage/damage to the appliance**

Cleaning agents and agents for pretreating laundry (e.g. stain removers, prewash sprays, etc.) may cause damage if they come into contact with the surfaces of the appliance. Therefore please note:

- Do not allow these agents to come into contact with the surfaces of the appliance.
- Clean the appliance with nothing but water and a soft, damp cloth.
- Remove any detergent, spray or other residues immediately.

**Cleaning the moisture sensor**

**Note:** The moisture sensor measures the amount of moisture in the laundry. After long periods of usage, the moisture sensor may become covered by a fine layer of limescale or detergent and care product residue. These deposits must be removed regularly, otherwise the drying results may not be optimal.

1. Open the door.

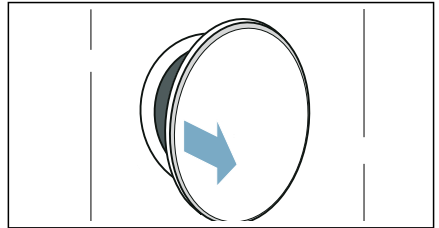

2. Clean the moisture sensor with a rough sponge.

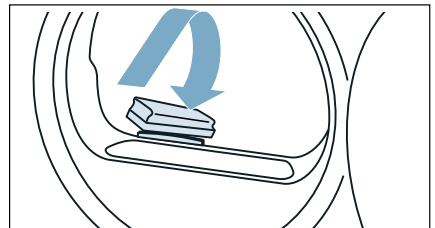
**Caution!****Risk of damaging the moisture sensor.**

The moisture sensor is made from stainless steel. Do not clean the sensor with abrasive cleaning products or wire wool.

## Cleaning the filter in the condensation container

**Note:** The filter in the condensation container cleans the condensation water, which is used during the appliance's automatic cleaning cycle.

1. Pull out the condensation container horizontally.

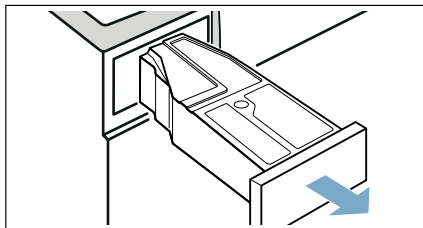

2. Pour out the condensation water.
3. Remove the filter.

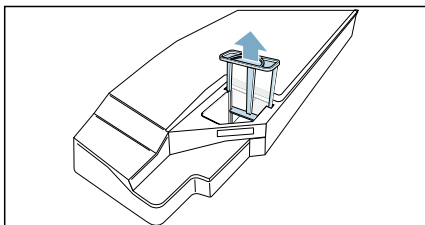

4. Clean the filter under warm, running water or in the dishwasher.
5. Push the filter in until you feel it lock into place.

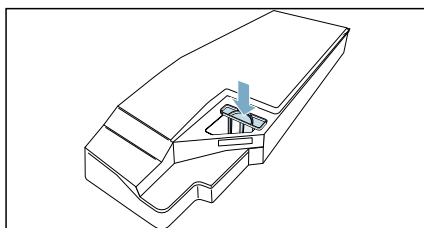

### Caution!



**If the filter is not inserted, fluff can find its way inside the appliance and damage it.**

Only operate the appliance with the filter inserted.

6. Push the condensation container in until you feel it lock into place.





## Information on the display

Faults	Cause/remedy
 on the display and drying has stopped.	<ul style="list-style-type: none"> <li>■ Empty the condensation container and reinsert it. → <i>Page 31</i> Press Start/Pause ▷00.</li> <li>■ Once you have installed the optional drain hose*, make sure that it: Is correctly connected → <i>Page 33</i> Is free of kinks Is not blocked or clogged, e.g. with deposits</li> </ul>
 on the display.	Remove the fluff. → <i>Page 32</i> Press Start/Pause ▷00.
 on the display.	Not a fault. The heat exchanger is being cleaned automatically. Do not pull out the condensation container while this is displayed.
The display goes out and Start/Pause ▷00 flashes.	Not a fault. Energy saving mode is active .
* Depending on how the appliance is equipped or the available accessory	

**Note:** If you cannot rectify the fault yourself by turning the appliance off and then on again, please contact our after-sales service. → *Page 45*

## Help with the appliance

Faults	Cause/Remedy
Appliance does not start.	Check the mains plug and the fuses.
Creasing.	<ul style="list-style-type: none"> <li>■ Load exceeded or incorrect programme selected for a type of fabric. All the required information can be found in the programme table. → <i>Page 23</i></li> <li>■ Remove laundry from the drum as soon as the drying programme has finished. Creasing occurs when clothing is left in the drum.</li> </ul>
Water is leaking out.	The appliance may be positioned at an angle. Level the appliance. → <i>Page 13</i>
Programme duration displayed changes as drying progresses.	Not a fault. The moisture sensor measures the residual moisture in the laundry and adjusts the programme duration (with the exception of timed programmes).
Laundry is not dried properly or is still too damp.	<ul style="list-style-type: none"> <li>■ After the programme has ended, warm laundry feels damper than it actually is. Spread out the laundry and let it cool down.</li> <li>■ Adjust the drying time or increase the degree of dryness. This will extend the drying time but the temperature will remain the same.</li> <li>■ Select a timed programme to add extra drying time for laundry that is still damp.</li> <li>■ Select a timed programme for a small load.</li> <li>■ Do not exceed the maximum load for a programme. → <i>Page 23</i></li> <li>■ Clean the moisture sensor in the drum. The sensor may become covered in a fine layer of limescale or detergent and care product residue, which then impairs its performance. → <i>Page 37</i></li> <li>■ Drying has been interrupted as a result of a power cut, because the condensation container is full or because the maximum drying time has been exceeded.</li> </ul> <p><b>Note:</b> See also the laundry tips. → <i>Page 27</i></p>
The programme does not start	<p>Make sure that:</p> <ul style="list-style-type: none"> <li>■ The door is closed</li> <li>■ The Child Lock 3 sec.  3 sec. has been deactivated</li> <li>■ You have pressed Start/Pause </li> </ul> <p><b>Note:</b> If the programme has been delayed by setting <b>Finished in</b> , the programme starts at a later point.</p>
Drying taking too long.	<ul style="list-style-type: none"> <li>■ The appliance may have fluff in it. This will increase the drying time. Remove the fluff. → <i>Page 32</i></li> <li>■ If the air inlet on the appliance is blocked or not fully open, the drying time may increase. Make sure that the air inlet remains unobstructed.</li> <li>■ If the ambient temperature is lower than 15 °C or higher than 30 °C, this may increase the drying time.</li> <li>■ Inadequate air circulation in the room may increase the drying time. Make sure the room is adequately ventilated.</li> </ul>

Humidity in the room is increasing.	Make sure the room is sufficiently ventilated.
Drying programme is stopped.	If the drying programme is stopped due to a power failure, restart the programme or remove the laundry and spread it out.
Unusual noises when drying.	Automatic cleaning of the heat exchanger produces noises. This does not indicate that there is a malfunction on the appliance.
The appliance feels cold despite drying.	Not a fault. The appliance can dry effectively at low temperatures using a heat pump.
Residual water in the condensation container despite the appliance being connected to the drain hose*.	If the optional drain hose is installed, residual water remains in the condensation container due to the appliance's self-cleaning function.
* Depending on how the appliance is equipped or the available accessory	

**Note:** If you cannot rectify the fault yourself by turning the appliance off and then on again, please contact our after-sales service. → *Page 45*



## Transporting the appliance

### Warning

#### **Risk of injury/material damage/ damage to the appliance!**

If you take hold of any of the appliance's protruding parts (e.g. the appliance door) in order to lift or move it, these parts may break off and cause injury. Do not take hold of any of the appliance's protruding parts in order to move the appliance.

### Warning

#### **Risk of injury!**

- The appliance is very heavy. Lifting it may result in injury. Do not lift the appliance on your own.
- The appliance has sharp edges on which you could cut your hands. Do not take hold of the appliance by its sharp edges. Wear protective gloves to lift it.

#### **Prepare the appliance for transportation as follows:**

1. Pull out the condensation container horizontally and empty it.

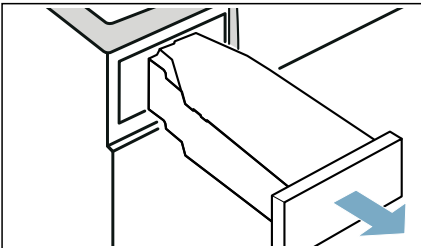

2. Push the condensation container back into the appliance until you feel it lock into place.

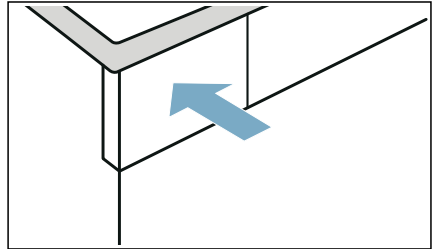

3. Switch on the appliance.
4. Set any programme.
5. Press **Start/Pause** .
6. Wait for 5 minutes. The condensation water will be drained.
7. Empty the condensation container again.
8. If installed, remove the drain hose from the washbasin, siphon or floor drain. → Page 33

#### **Caution!**

Secure the drain hose to the appliance to prevent it from slipping out. Do not kink the drain hose.

9. Switch off the appliance.
10. Disconnect the appliance's mains plug from the power supply.

The appliance is now ready to be transported.

#### **Caution!**

#### **Risk of material damage/damage to the appliance**

Despite draining, there will always be some residual water in the appliance. Any residual water may leak out and cause material damage.

The appliance should therefore be transported upright.



## Consumption values

### Consumption values table

Programme	Spin speed used for spinning the laundry (in rpm)	Duration** (in min)	Energy consumption** (in kWh)
<b>Cottons</b>		<b>9 kg</b>	<b>9 kg</b>
Cupboard Dry	1400	146	1.77
	1000	166	2.06
	800	186	2.35
Iron Dry	1400	109	1.26
	1000	129	1.55
	800	149	1.84
<b>Synthetics</b>		<b>3.5 kg</b>	<b>3.5 kg</b>
Cupboard Dry	800	57	0.55
	600	65	0.65
* Programme setting in accordance with the applicable IEC61121 standard when using the external drain hose.			
** The values may differ from those specified, depending on the type of fabric, composition of laundry to be dried, residual moisture in the laundry, the degree of dryness that has been set, the amount of laundry being loaded, the environmental conditions, and any additional functions that have been activated.			



## Technical data

### Dimensions:

850 x 600 x 600 mm

(height x width x depth)

### Weight:

57 kg (depending on the model)

### Mains connection:

Mains voltage 220 - 240 V, 50 Hz

Nominal current 10 A

Nominal power max. 1000 W

### Maximum load:

9 kg

### Drum interior light\*

### Ambient temperature:

5 - 35 °C



## Disposal



Dispose of packaging and the appliance in an environmentally responsible manner.

This appliance is labelled in accordance with the European Directive 2012/19/EU, which governs waste electrical and electronic equipment (WEEE). The directive provides a framework for the collection and recycling of old appliances, which is valid across the EU.

### Caution!

#### Risk of fire/risk of poisoning/risk of material damage and damage to the appliance

The appliance contains R290, a refrigerant that is environmentally friendly but flammable. If it is not disposed of correctly, this may result in fire or poisoning.

Dispose of the appliance correctly and do not damage the pipes in the refrigerant circuit.

\* Depending on the appliance features



## Customer Service

If you cannot rectify the error yourself by turning the appliance off and then on again, please contact our after-sales service. → Enclosed after-sales service directory or cover page

We will always find an appropriate solution and, where possible, prevent the need for an engineer to visit.

Please provide the after-sales service with the product number (E no.) and the production number (FD) of the appliance.

E-Nr. \_\_\_\_\_ FD \_\_\_\_\_

E no.      Product number  
FD        Production number

You can find this information,  
\*depending on the model:

On the inside of the door\*/open service flap\* and at the rear of the appliance.

**You can trust in the manufacturer's expertise.**

Contact us. This ensures that the repair is carried out by trained service engineers with genuine spare parts.







## Thank you for buying a Bosch Home Appliance!

Register your new device on MyBosch now and profit directly from:

- **Expert tips & tricks for your appliance**
- **Warranty extension options**
- **Discounts for accessories & spare-parts**
- **Digital manual and all appliance data at hand**
- **Easy access to Bosch Home Appliances Service**

Free and easy registration – also on mobile phones:

[www.bosch-home.com/welcome](http://www.bosch-home.com/welcome)



## Looking for help? You'll find it here.

Expert advice for your Bosch home appliances, need help with problems or a repair from Bosch experts.

Find out everything about the many ways Bosch can support you:

[www.bosch-home.com/service](http://www.bosch-home.com/service)

**Contact data of all countries are listed in the attached service directory.**

### **Robert Bosch Hausgeräte GmbH**

Carl-Wery-Straße 34

81739 München, GERMANY

[www.bosch-home.com](http://www.bosch-home.com)



**9001434156** (9906)

en