

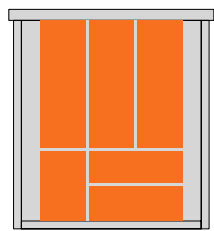

Gợi ý lựa chọn các mẫu khay chia theo chiều rộng ngăn kéo tiêu chuẩn  
Mix & match suggestion by standard drawer widths

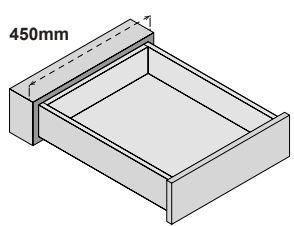

B13

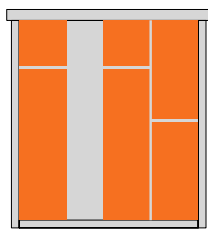

B1 + K12

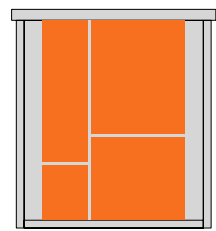

F13

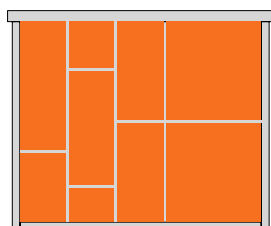
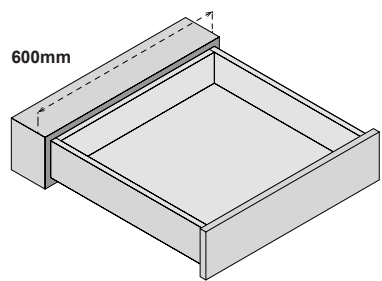

F13 + K12

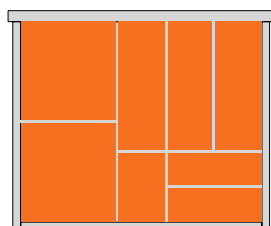

B13 + K12

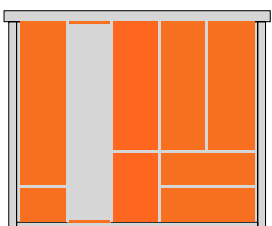

T15

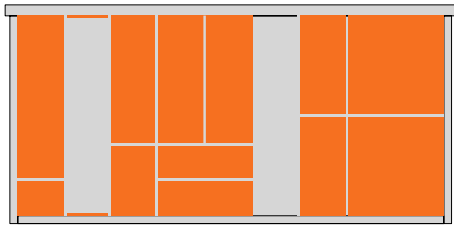
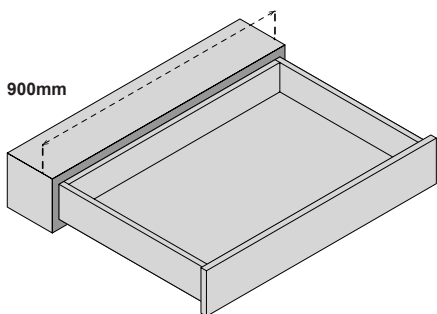

T15 + K12

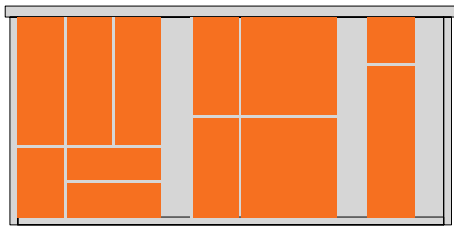

B13 + K12 + B11